



SURGICALLY CLEAN AIR™

SCA14000 (COBALT)

INSTALLATION MANUAL

Read the manual thoroughly before operation and retain for future reference.



REV SCA14000-IM-03

TABLE OF CONTENTS

DISCLAIMER -----	2
SAFETY PRECAUTIONS -----	3-6
FEATURES AND SPECIFICATIONS -----	7
WHAT'S INCLUDED -----	8-9
INSTALLATION BOM LIST -----	10
INSTALLATION REMARKS -----	11-13
ELECTRICAL SUPPLY REMARKS -----	14
INSTALLATION INSTRUCTIONS -----	15-20
CONCRETE CEILING -----	15-18
I-BEAM CEILING/ RECESS MOUNTED -----	19-20
ELECTRICAL WIRING INSTRUCTIONS -----	21
WALL-MOUNT INSTALLATION -----	22-24
MOBILE STAND INSTALLATION -----	25-26
CARE AND MAINTENANCE -----	27
TROUBLESHOOTING -----	28-29

DISCLAIMER

A printed copy of all the electronic materials is included in the unit packaging.

The ceiling installation of the unit should be performed by a certified professional.

Read the label on the unit, operation and installation manuals before use and make sure you follow all the precautions outlined in the manuals.

The manufacturer disclaims all liability for damage or injury incurred by disregarding the instructions in this document, negligence in the installation, use, maintenance, or repair of the product identified in this document, or by failure to strictly abide by these safety precautions and instructions.

The product's user is always totally responsible for adhering to any local safety laws and regulations that may be in effect.

INTENDED USE

The SCA14000 Air Purifier is intended to remove particles from the air.

Using attachments, filters and/or any other components not recommended and approved by Surgically Clean Air™ will void the warranty.

For Commercial or Industrial Use Only.

DIRECTIONS FOR USE

Follow the instructions to ensure proper installation. The display panel will turn on and the “Surgically Clean Air™” LED will light up if the unit is powered on.

DISPOSAL INSTRUCTIONS

Dispose of filters according to local regulations based on the location of use (e.g., medical waste if used in a medical setting such as dental clinics, laboratories, etc.).

SAFETY PRECAUTIONS

FIRST AID INSTRUCTIONS

In case of injury, clean the area using soap and warm water, apply antibiotic ointment and a bandage, and seek immediate medical attention.

OPERATING ENVIRONMENT CAUTIONS

- DO NOT place in rooms with high heat, damp, or wet places.
- DO NOT use outdoors.
- DO NOT use extension cord with this fan.
- Not for use in kitchens.
- DO NOT remove (or attempt to remove) any part of the unit except for the filters.
- Best operating environment is 50 -104 °F or 10 – 40 °C.
- Ensure the unit is level. Never use when it is tilted.
- Use only a 120-volt outlet with a grounding wire receptacle.
- To reduce the risk of electric shock, this equipment has a grounding-type plug that has a third (grounding) pin. This plug will only fit into a grounding-type power outlet. If the plug does not fit into the outlet, contact qualified personnel to install the proper outlet. DO NOT alter the plug in any way.

WARNING

– TO REDUCE THE RISK OF FIRE, ELECTRIC SHOCK, OR INJURY TO PERSONS, OBSERVE THE FOLLOWING:

- a) Use this unit only in the manner intended by the manufacturer. If you have questions, contact the manufacturer.
- b) Before servicing or cleaning unit, switch power off at service panel and lock the service disconnecting means to prevent power from being switched on accidentally. When the service disconnecting means cannot be locked, securely fasten a prominent warning device, such as a tag, to the service panel.

SAFETY PRECAUTIONS

WARNING

– THIS DEVICE SHOULD NOT BE USED IN A CONSTRUCTION ZONE. Extensive amounts of particulates such as construction dust and debris will clog up the filter and impact the efficiency of the unit. If construction needs to be conducted in an area where Cobalt units are installed, it is recommended that the unit is turned off. After the construction is concluded in the area, units are to be vacuumed and filters replaced.

UNIT OPERATION CAUTIONS

- This manual's contents must be thoroughly understood by anyone working on or with the product. Operators and personnel must adhere to the contents of this manual.
- Never change the sequence of the operations to be carried out.
- Always keep the manual in the vicinity of the product.
- DO NOT insert fingers or foreign objects into the intake or air outlet.
- Keep hair, loose clothing, fingers, and all parts of your body away from openings and moving parts.
- In the event the machine starts to make excessive vibrations or noise, overheats, or starts to smell, stop using the equipment immediately. Turn off the machine and disconnect the power and contact the manufacturer.
- DO NOT use the air purifier if the power cord or plug is damaged or the connection to the outlet is loose.
- When removing the plug, always hold the plug and never pull by the cord.
- DO NOT use the unit near hot objects, or where it may be exposed to steam or open flame.
- DO NOT obstruct the air inlets or outlets of the unit.
- To avoid the risk of fire, shock, and injury, DO NOT disassemble the unit. Contact a certified technician for service.

SAFETY PRECAUTIONS



WARNING

- TO REDUCE THE RISK OF ELECTRIC SHOCK, DO NOT expose to water or rain.
- RISK OF FIRE OR ELECTRIC SHOCK, DO NOT use this equipment with any solid-state speed control device.
- TO REDUCE THE RISK OF FIRE, ELECTRIC SHOCK, OR INJURY TO PERSONS, DO NOT use replacement parts that have not been recommended by the manufacturer.
- TO REDUCE THE RISK OF FIRE, ELECTRIC SHOCK, AND INJURY TO PERSONS, Cobalt unit must be installed with brackets and screws that are marked in the installation manual to indicate the suitability with this model. Other types of brackets and fasteners cannot be substituted.
- TO REDUCE THE RISK OF PERSONAL INJURY, DO NOT bend the blade brackets when installing the brackets, balancing the blades, or cleaning the fan. DO NOT insert foreign objects in between rotating fan blades.
- This appliance is not intended for use by persons (including children) with reduced physical, sensory, or mental capabilities, or lack of experience and knowledge, unless they have been given supervision or instruction concerning the use of the appliance by a person responsible for their safety. Children should be supervised to ensure that they DO NOT play with the appliance.
- If the supply cord is damaged, it must be replaced by the manufacturer, its service agent, or similarly qualified persons in order to avoid a hazard.
- For recessed mounting installations, a disconnection incorporated in the fixed wiring is to be provided.

SAFETY PRECAUTIONS

CARE AND MAINTENANCE/ SERVICING CAUTIONS

WARNING

– RISK OF FIRE. Never operate the air purifier in a space that contains flammable gases. Never use the equipment to extract or filter flammable, blazing or burning particles, chemicals, or liquids. Never use the unit to extract or filter hostile vapors or sharp particles.

– RISK OF ELECTRIC SHOCK. These servicing instructions are for use by qualified personnel only. DO NOT perform any servicing other than that contained in the operating instructions unless you are qualified to do so.

– HIGH VOLTAGE INSIDE. Disconnect power before installation, servicing or replacing filters.

CAUTION – AUTOMATICALLY OPERATED DEVICE –To reduce the risk of injury disconnect from power supply before servicing.

FEATURES AND SPECIFICATIONS

The device features:

- Automatic Proximity Sensor On/Off
- Automatic Timer
- Remote Control

Model No.	SCA14000–2x4
Power Requirement	120V, 60 Hz
Rated Power	250 W, 2.1A
Fan Motor	310 VDC, 0.98 A, 113 W
Dimensions	(L) 1245.0 mm x (W) 636.0 mm x (H) 360.0 mm
Weight	45 kg

Model No.	SCA14000–2x2
Power Requirement	120V, 60 Hz
Rated Power	75 W, 1.1 A
Fan Motor	24 VDC, 1.14 A, 27.5 W
Dimensions	(L) 636.0 mm x (W) 636.0 mm x (H) 255.0 mm
Weight	20.5 kg

WHAT'S INCLUDED

MAIN PRODUCT

Below items are included with the SCA14000 air purifier:

1. Cobalt Unit
2. H13 Filters (x2), included in the unit
3. Mount Bracket (x4)
4. ¼" Screws (x8)
5. Remote Control
6. Remote Control AAA Battery (x2)

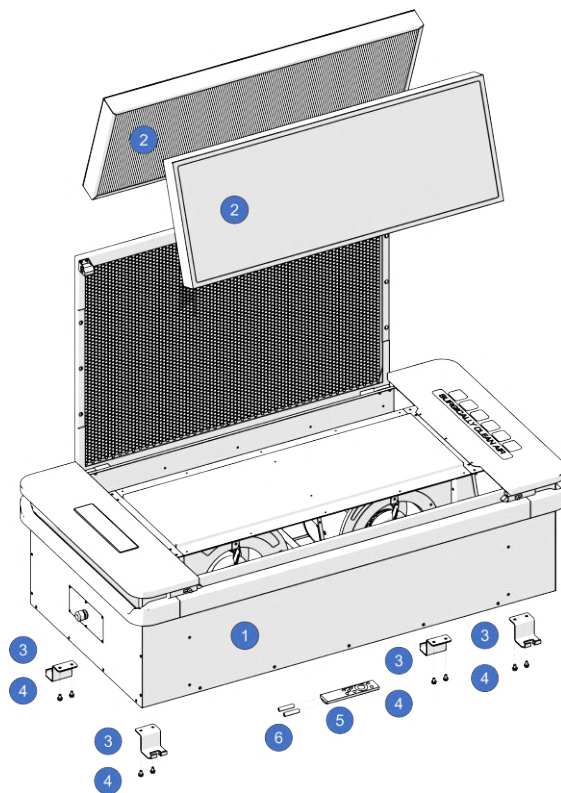

WHAT'S INCLUDED

The below accessories are available as alternative installation options.

These components are not included in the main package, and need to be purchased separately:

WALL-MOUNT ACCESSORIES

The below accessories are provided for wall-mount installation option:

- 2x4 Unit
 - 46 ¼" Bar (x2)
 - 17 ½" Bar (x2)
 - Bracket (x1)
 - ¼" Screws (x17)
- 2x2 Unit
 - 22 ½" Bar (x2)
 - 17 ½" Bar (x1)
 - ¼" Screws (x13)

MOBILE STAND ACCESSORIES

The below accessories are provided for mobile stand option:

- 2x4 Unit
 - 53" Bar (x2)
 - 23" Bar (x2)
 - 23" Support Bar (x1)
 - 24 ¾" × 7" Base Support U Bar (x1)
 - Mobile Cart (x1)
 - ¼" Screws (x28)
- 2x2 Unit
 - 27" Bar (x2)
 - 23" Bar (x2)
 - 23" Support Bar (x1)
 - 24 ¾" × 4 ¾" Base Support U Bar (x1)
 - Mobile Cart (x1)
 - ¼" Screws (x28)

INSTALLATION BOM LIST (NOT INCLUDED IN PACKAGING)

Below items are required for the SCA14000:

NO.	NAME	QTY	REMARK	INSTALLATION TYPE
1	Hanging Bar	4	$\frac{3}{8}$ " Threaded Rod 100+ lbs. rated	Concrete Ceiling/ I-Beam Ceiling
2	Expansion Bolt	4	$\frac{3}{8}$ " Expansion Bolt 100+ lbs. rated	Concrete Ceiling
3	Washer	4	$\frac{3}{8}$ " Fender Washer	Concrete Ceiling/ I-Beam Ceiling
4	Rubber Washer	4	$\frac{3}{8}$ " Rubber Washer	Concrete Ceiling
5	Nut	4	$\frac{3}{8}$ " Nut *Lock Nut Recommended	Concrete Ceiling/ I-Beam Ceiling
6	Eye Bolt	4	$\frac{3}{8}$ " Eye Bolt with Shoulder, 100+ lbs. angular load rated	I-Beam Ceiling
7	Wire Rope & Clamp	As Required	Wire Rope & Applicable Clamp 100+ lbs. rated	Concrete Ceiling/ I-Beam Ceiling
8	L-Bracket	4	L-Bracket for Concrete Ceiling with Wire Rope Installation 100+ lbs. rated	Concrete Ceiling
9	Aluminum Crimp Loop	As Required	Compatible to wire rope size, 100+ lbs. rated	I-Beam Ceiling
10	Metal-Clad Jacket for power cord, Plenum Rated	As Required	For plenum installation, power cord MUST be rated to local codes and requirements.	Concrete Ceiling/ I-Beam Ceiling

INSTALLATION REMARKS

The SCA14000 is designed to be installed as a fixed built-in unit by a qualified installer. In addition to the following instructions the SCA14000 shall be installed:

- In the United States, in accordance with the National Electric Code/State, ANSI/NFPA 70 and Municipal codes and/or local codes.
- In Canada, in accordance with the Canadian Electric Code C22.1 - latest edition/Provincial and Municipal codes and/or local codes.

UNPACKING

While unpacking the product please follow the instructions and markings on the packaging.

INSPECTION

After unpacking the air purifier and prior to installation, thoroughly inspect the unit for freight or cosmetic damage. Report any damage immediately.

REQUIRED TOOLS

- Ladder/ Lift
- Work gloves and safety glasses
- Wire Stripper
- Screwdriver (Manual or Impact)
- Allen Key
- Level
- Hammer Drill

INSTALLATION REMARKS

- The Cobalt unit can be hoisted from the concrete ceiling or the I-beam.
- Ensure the unit is being installed level in both directions.
- Follow ceiling tile system manufacturer instructions for integration compatibility.
- Install the filters after the building is completely clean of construction debris and dust.
- Be sure to **remove any plastic wrapping** from the HEPA filters prior to installing them in the unit and operating the equipment.
- If lift assist equipment is being used to lift the equipment to position, ensure padding is placed under the unit to **prevent damage** and unwanted scratches to the front mesh panel. Padding is available inside the packaging.
- It is recommended that installation is performed by two people.
- Ensure the equipment is adequately supported at all 4 corners to support the weight of the unit. If needed install supplementary hanger rods on the existing supports (not supplied).
- A lubricant should not be used on any mounting screw.



INSTALLATION REMARKS

CHOOSING THE LOCATION

- Choose a location with the following conditions:
 - A. Indoor Space
 - B. Operating Temperature: 50 -104 °F (10 – 40 °C), Relative Humidity: <75%
- Built-in fixed units must be unobstructed from the front.
- For new installation, the installation work must be done by a qualified installer before the air purifier is moved into place.
- It is recommended that Cobalt unit is positioned centrally within a room. It is important that the intake side of the unit is away from the supply of the HVAC system. To improve air quality in the room, the unit should circulate and filter the existing air in the room, not the fresh air supplied by the HVAC system. Likewise, the position of the exhaust side of the unit should be away from the return ducts of the HVAC system. This is to ensure that the clean air coming from the unit is not immediately taken out of the room by the HVAC system.

WARNING

- SUPPORT DIRECTLY FROM THE BUILDING STRUCTURE IF INSTALLED IN THE CEILING.
- TO REDUCE THE RISK OF FIRE, ELECTRIC SHOCK, OR INJURY TO PERSONS OBSERVE THE FOLLOWING:
 - a) Installation work and electrical wiring must be done by qualified person(s) in accordance with all applicable codes and standards, including fire-rated construction.
 - b) When cutting or drilling into a wall or ceiling, DO NOT damage electrical wiring and other hidden utilities.
- MAKE SURE THE POWER IS OFF BEFORE ATTEMPTING INSTALLATION.

ELECTRICAL SUPPLY REMARKS

- The customer has the responsibility to ensure that the unit installation is in compliance with all national and local electrical and building codes and ordinances. The electrical supply which the unit is designed for is 120VAC, 60 Hz.
- All wiring and materials must comply with all National/ State/ Municipal and/or local codes and ordinances including but not limited to ANSI/NFPA 70 and Canadian Electric Code C22.1.
- The receptacle shall be accessible and connected to an electrical supply circuit with a fuse or breaker rated for 15.0 Amps. Receptacles shall be located to avoid physical damage to the flexible cord.
- No other appliances should be connected to the air purifier supply circuit.
- The power cord is prohibited for recessed mounting. Conduit wiring shall be used for recessed mounting.

 **WARNING** – If the maximum ampere rating is more than 50 percent of the rating of the branch circuit, connect only to a dedicated branch circuit. Do not use an extension cord with this equipment.

INSTALLATION INSTRUCTIONS

CONCRETE CEILING

1. Determine the installation location; the reinforced concrete ceiling must be selected for installation.

2. Draw rectangles at the installation position with dimensions as follows :

- SCA14000-2x4: 1037mm*490mm

- SCA14000-2x2: 490mm*490mm

The four vertices of the rectangle are the anchor points for installing the expansion screw.

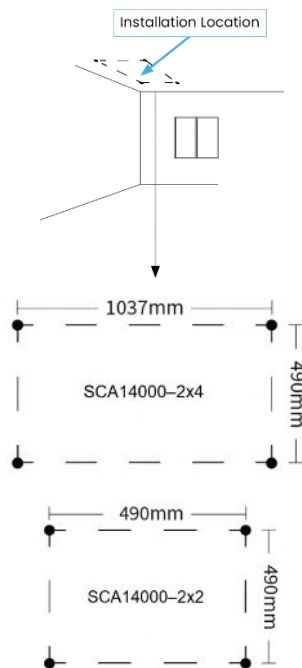

3. Use an electric hammer to drill holes in four anchor points, ensuring a minimum depth of two inches into the slab and install expansion screws.

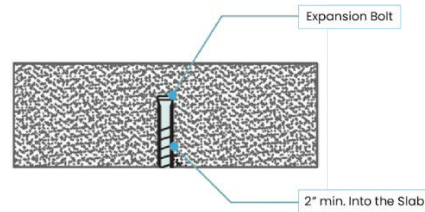
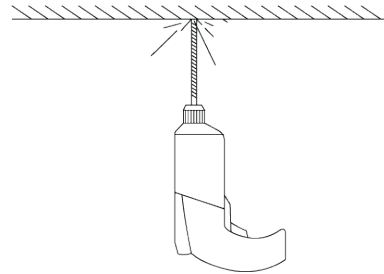

4. Drive the expansion screw, screw in the threaded rod, and then screw in the four Nuts, where nut 3 is next to nut 4. The position of each screw should be at the same height from the ceiling.

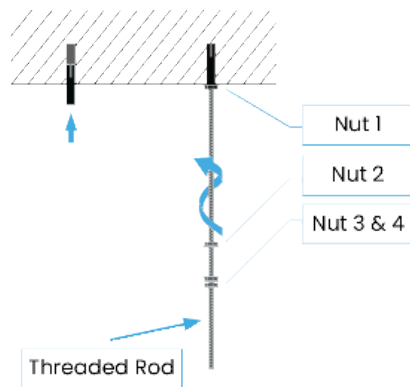

5. Load all the four cabinet hangers into nut 3.

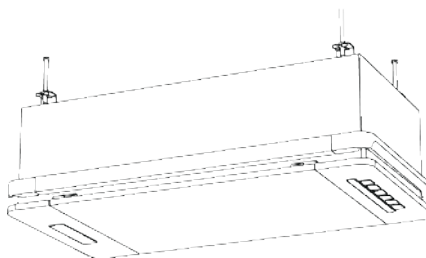

6. Using a level in both directions, adjust nut 3 and nut 4 to ensure the machine is leveled horizontally. Finally tighten nuts 3 and 4 to fix the machine in place, connect the power to complete the installation.

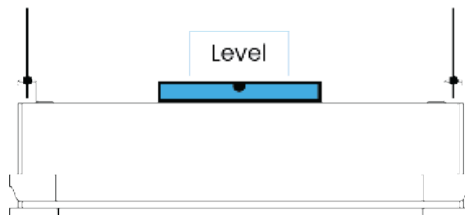

7. Plug the power cable into power supply socket.

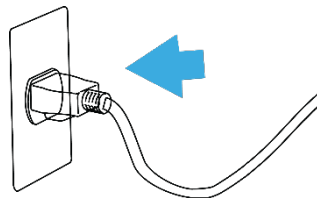

CEILING INSTALLATION

I-BEAM CEILING/ RECESS MOUNTED

1. Determine the installation location; the I-Beam structure must be directly under the suspended ceiling opening or desired area.

2. Make note of the position of eye bolts:

- SCA14000-2x4: 1037mm*490mm

- SCA14000-2x2: 490mm*490mm

The four vertices of the rectangle are the anchor points for positioning the wire rope.

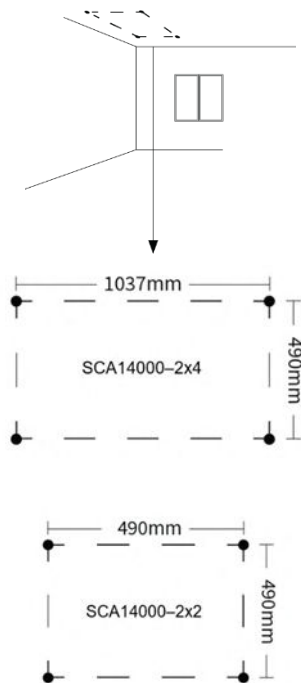

3. Secure the eye bolts (4x) to the back of the ceiling unit.

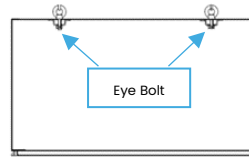

4. Secure the wire rope to the I-Beam based on eye bolt location as shown. For concrete ceiling, use expansion bolt and L-bracket to secure the wire rope to the concrete ceiling.

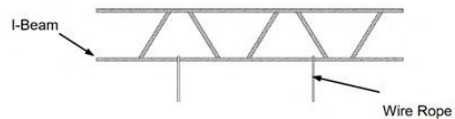

5. Attach the wire rope to the eye bolts, adjust to ensure the unit is flush to the suspended ceiling and is level in both directions.

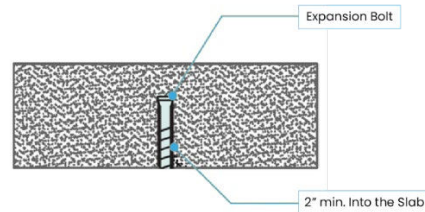

Leveling the unit is essential for load balancing.

6. The Cobalt unit is supplied with a connected power cord. Supplied power cord is prohibited for use in recess mounting installations. Please refer to "Electrical Wiring Instructions" for recess mounted installations.

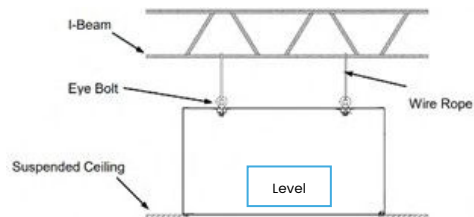

ELECTRICAL WIRING INSTRUCTIONS

INSTRUCTIONS TO HARD WIRE 120V, 60 HZ:

For Recess Mount installations, the power cord needs to be hard wired and have a conduit. Please follow the instructions below to hard wire the power cord:

1. Remove the 6 bolts from the conduit front panel.
2. Run the power cord through the bushing and the front panel opening.
3. Secure the power cord by tightening the bushing attachment.
4. Run three (3) color coded wires to the wiring box of the unit.
Ensure the wire tips are stripped and tinned for better grip in the terminal.
5. Attach the ground wire to the ground terminal marked \oplus in the wiring box.
Attach the Live wire to the terminal marked "L" and the Neutral wire to the terminal marked "N" in the wiring box.
6. Screw the 6 bolts back in place.

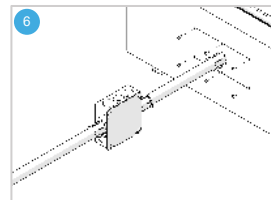
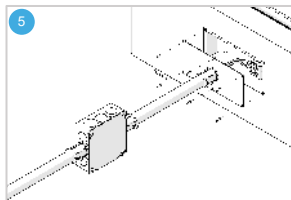
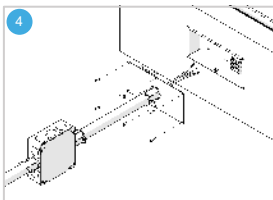
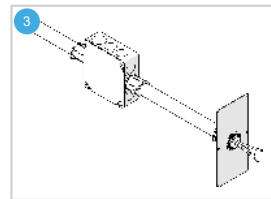
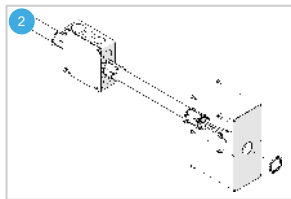
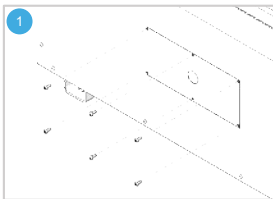

WALL-MOUNT INSTALLATION

1. Assemble the wall mount as shown, use the fitted screws (4x on each bracket) to fix the frame.

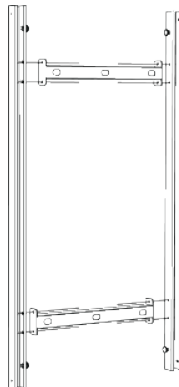

2. Select the installation location, place the frame on the wall, and use a level to adjust the location, mark the screw holes (16 counts).

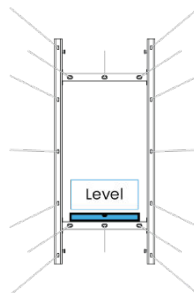

3. Drill holes at the point marked and install the anchors.

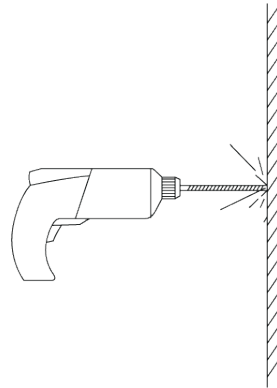

4. Install the frame on the wall using screws, ensure the frame is installed level.

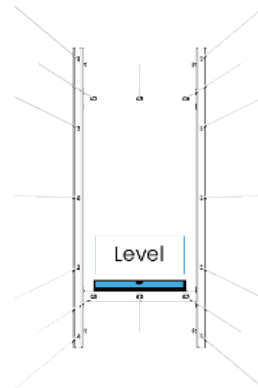

5. Install hooks on the back of the machine and secure them with screws.

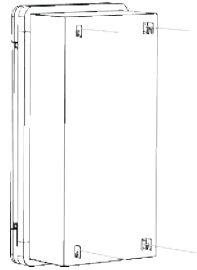

6. Mount the machine onto the wall bracket hooks.

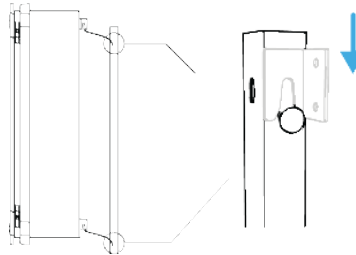

7. Plug the power cable into power supply socket.

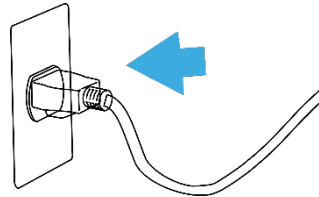

MOBILE STAND INSTALLATION

1. Assemble the stand mobile cart as shown.

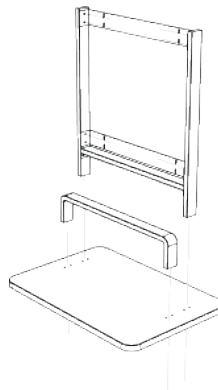

2. Place the machine on the small bar and rest it against the frame.

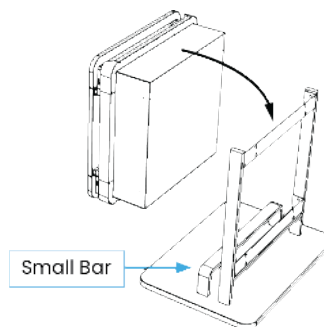

3. Fix the machine onto the cart with screws from the back.

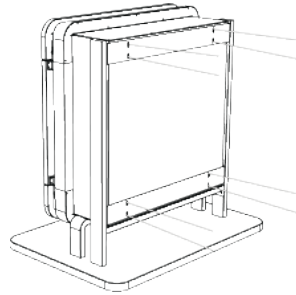

4. Plug the power cable into power supply socket.

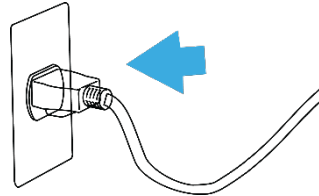

CARE AND MAINTENANCE

If the device is operating in an atmosphere with heavy dust, particulate, or pet dander, you may need to periodically vacuum the pre-filters for optimal performance.



CAUTION:

- DO NOT clean the filters and any other parts with liquid, especially alcohol, gasoline, paint thinner, etc. It may cause a risk of fire!
- Make sure all the filters are installed properly before operating the unit.
- When conducting maintenance on the unit, be sure the unit is turned off and the plug is disconnected from the outlet.
- Never handle the plug with wet hands. If so, electrical shock and bodily injury may occur as a result.

CLEANING THE UNIT

Wipe with a dry, soft cloth for stubborn stains or dirt. **Do not use volatile fluids, benzene, paint thinner or polishing powder** as this may damage the surface.

Do not use detergents as detergent ingredients may also damage the unit. Keep the unit away from water.

TROUBLESHOOTING

Most service problems that appear to be major can often be resolved easily. You can be your own troubleshooter by reviewing the following guide. All other major servicing should be done by the manufacturer.

NO.	FAILURE	POSSIBLE CAUSE	SOLUTION
1	Unit is inoperable	Main circuit breaker in not ON	Turn main circuit breaker to ON position
		Blown main circuit breaker fuse	Replace the main circuit breaker fuse
		Unit not hardwired correctly	Refer to "Electrical Wiring Instructions" and confirm proper hardwiring
		Wires disconnected from mains or soft set	Refer to "Electrical Wiring Instructions" and confirm proper hardwiring
		Damaged power cord	Replace damaged power cord
2	Fan works but the air cleaner functions poorly or not at all (reduced airflow or poor filtration)	Plastic wrapping not removed from one or both filters	Remove plastic wrapping from filters
		Air outlets blocked	Inspect and remove any blockage from air outlets at both ends of the unit
		One or both pre-filters are fully loaded	Vacuum the pre-filters

		One or both HEPA filters are fully loaded	Replace HEPA filter(s)
3	“Surgically Clean Air™” LED flashing	Filter change cycle timer expired	Replace HEPA filters and reset the timer
4	Remote Control is inoperable	Battery nearly exhausted	Replace batteries
		Unit's display panel is covered	Confirm and remove any obstruction in front of the display panel



SURGICALLY CLEAN AIR™

1A - 6300 Viscount Road

Mississauga, Ontario

Canada, L4V 1H3

Tel: 1-877-440-7770

www.surgicallycleanair.com

info@surgicallycleanair.com